

REVISIONS

P	LTR	DESCRIPTION	DATE	DWN	APVD
A2		2314277-2 RELEASED	31 JUL 2018	SM	-
B1		REVISED PER ECR-21-106881	28 OCT 2021	SR	JL

ABSOLUTE MAXIMUM RATINGS	SYMBOL	MIN	MAX	UNIT
STORAGE TEMPERATURE	Tstg	-40	85	°C
POWER SUPPLY INPUT VOLTAGE	Vdd	3.1	3.5	VDC
TOTAL SYSTEM CURRENT DRAW	Id	x	10	mA

ELECTRICAL CHARACTERISTICS	MIN	MAX	UNIT
ANALOG AUDIO OUTPUT SENSITIVITY	-25	-19	dBV
ANALOG AUDIO OUTPUT FREQ RANGE	100	10k	Hz

ENVIRONMENTAL CHARACTERISTICS	MIN	MAX	UNIT
OPERATING TEMPERATURE	-5	50	°C
RELATIVE HUMIDITY OPERATING, NON-CONDENSING ENVIRONMENT	5	95	%

ITEM: SENSOR	SENSOR PERFORMANCE
1: TEMPERATURE	-5°C TO +50°C ±0.3°C ACCURACY, 1 SECOND ACQUISITION RATE
2: RELATIVE HUMIDITY	5% TO 95% RH, 2% ACCURACY, 1 SECOND ACQUISITION RATE
3: MOTION	INTERRUPT DRIVEN, RESPONSE <0.5 SECS.
4: AMBIENT LIGHT LEVELS	1 SECOND ACQUISITION RATE
5: MICROPHONE	INTERRUPT DRIVEN, RESPONSE <0.5 SECS.

NOTES:

1. THIS PRODUCT HAS NOT COMPLETED VALIDATION TESTING,
2. MUST COMPLY WITH DIRECTIVE 2002/95/EC (ROHS).
3. SEPARATE LENS IS AVAILABLE UNDER TE P/N: 2317697-1.
4. OBSOLETE

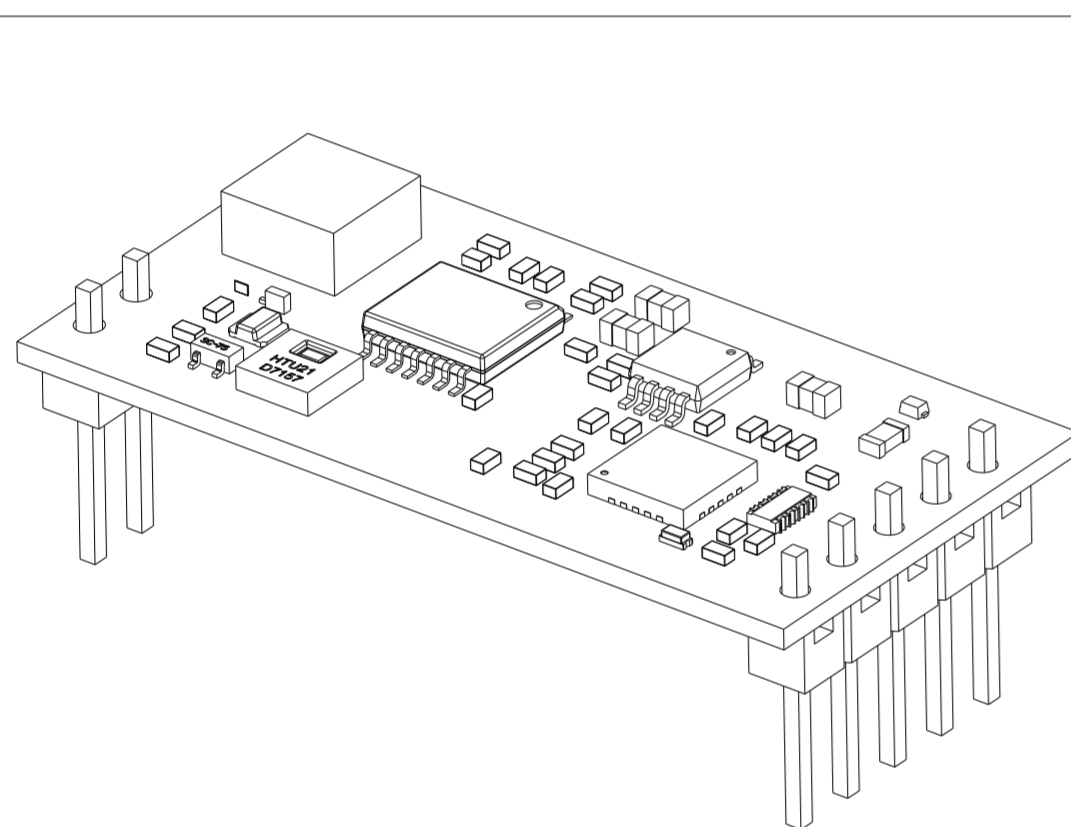

2314277-1 SHOWN

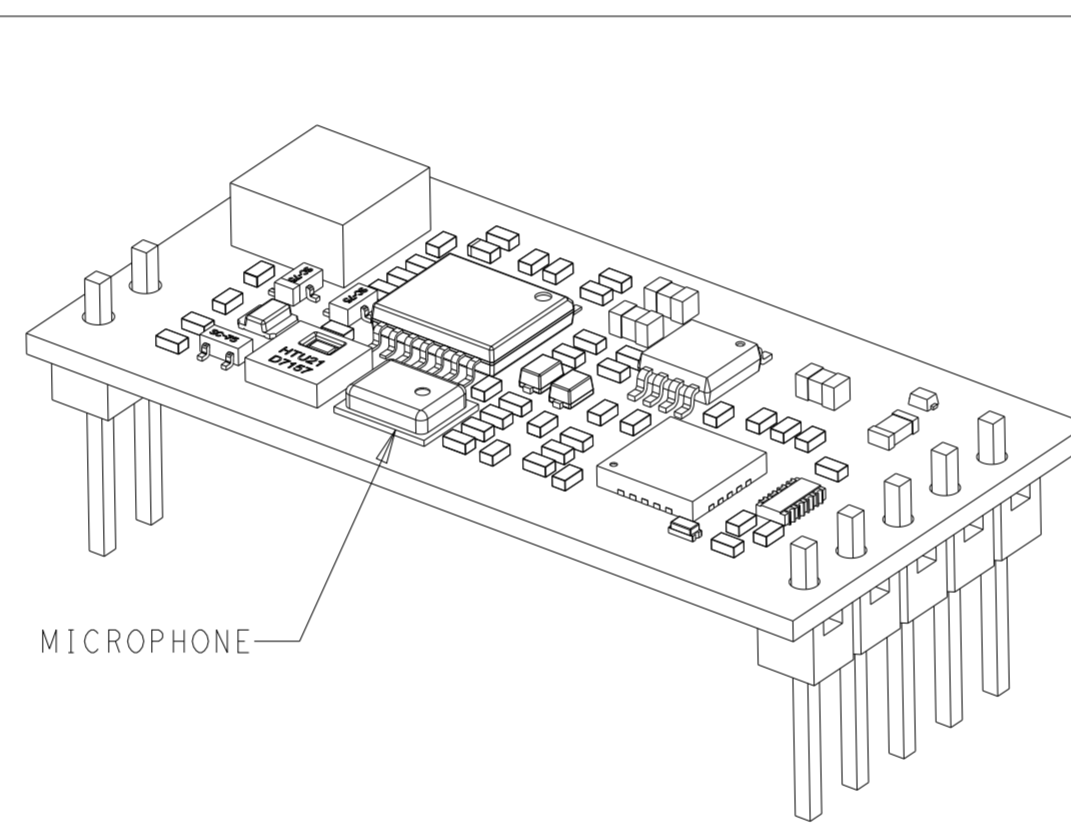

MICROPHONE

2314277-2 SHOWN

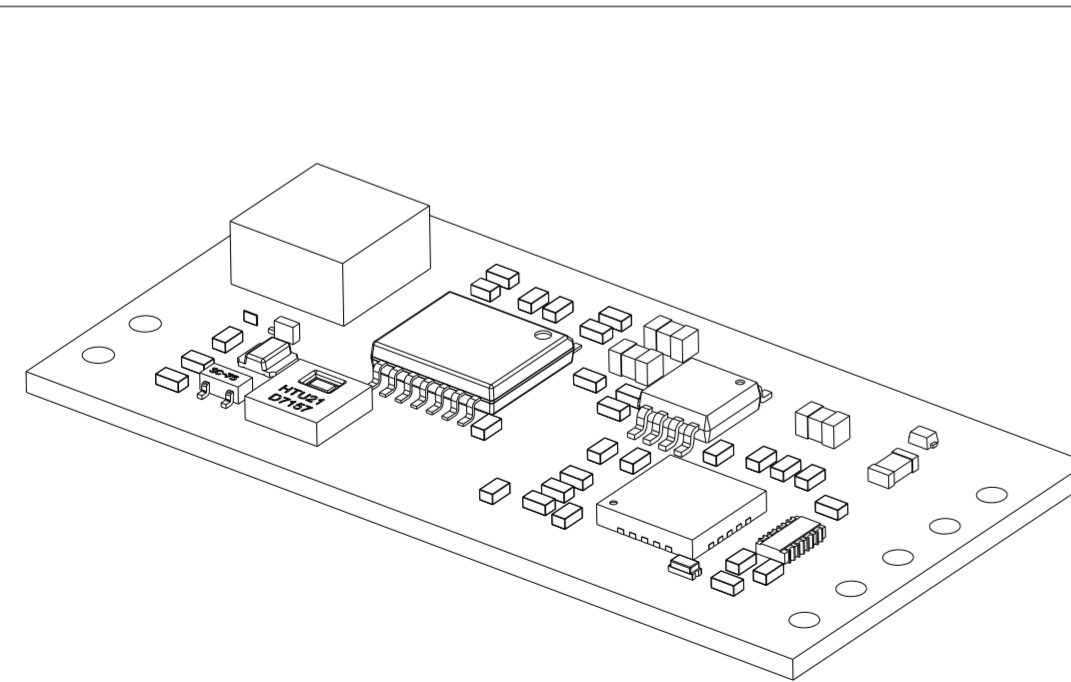

1-2314277-1 SHOWN

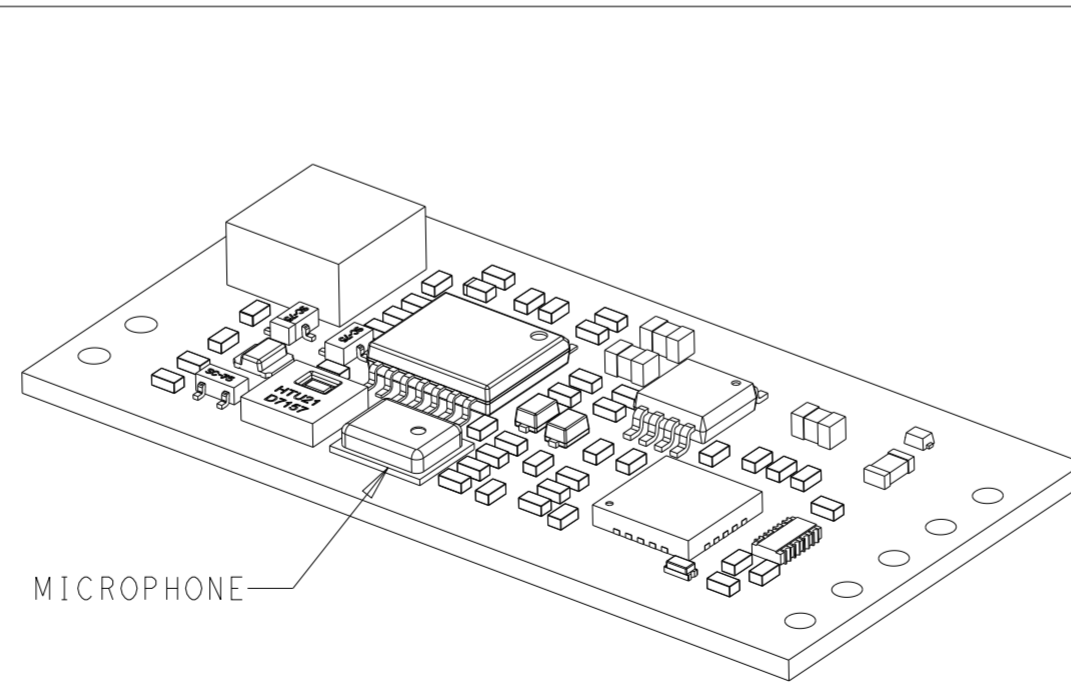

MICROPHONE

1-2314277-2 SHOWN

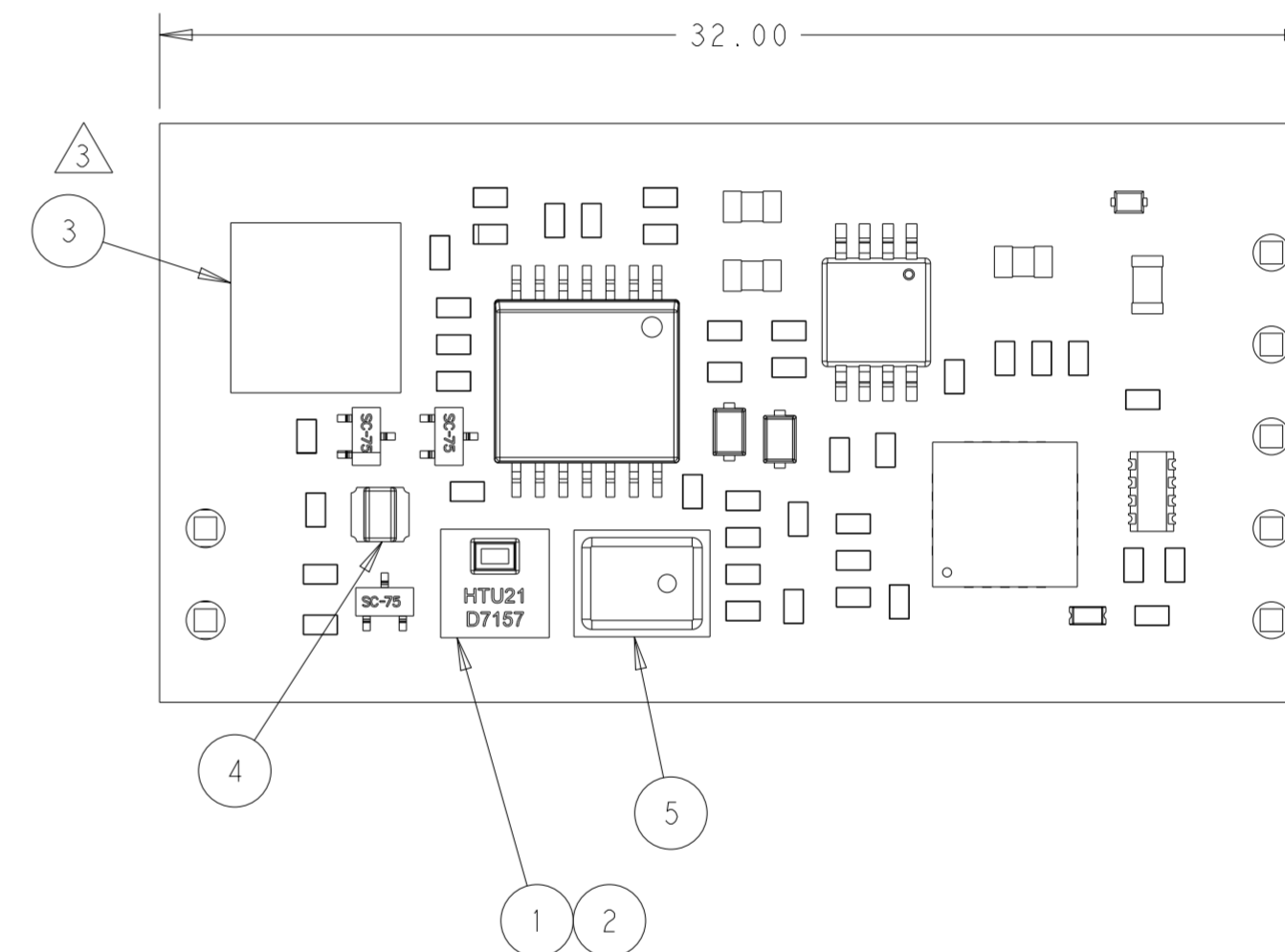

W/MICROPHONE, W/O HEADER	A	1-2314277-2
W/O MICROPHONE, W/O HEADER	A	1-2314277-1
W/MICROPHONE, W/HEADER	A	2314277-2
W/O MICROPHONE, W/HEADER	A	2314277-1
COMMENTS	REV	PART NO.

THIS DRAWING IS A CONTROLLED DOCUMENT.		DWN J. SHAFFER 10MAR2017	TE Connectivity	
		CHK C. GINGRICH 10MAR2017		
DIMENSIONS: mm	TOLERANCES UNLESS OTHERWISE SPECIFIED:	APVD -	NAME AMBIMATE, MSM4 SENSOR MODULE, THRU HOLE - PIN HEADER	RESTRICTED TO
	0 PLC ±	PRODUCT SPEC 108-133092	SIZE A2	
	1 PLC ±0.4	APPLICATION SPEC 114-133092	CAGE CODE -	
	2 PLC ±0.25	WEIGHT -	DRAWING NO C-2314277	
	3 PLC ±	CUSTOMER DRAWING	SCALE 3:1	SHEET 1 OF 2
	4 PLC ±			REV B1
	ANGLES ±			
	FINISH ±			

REVISIONS

P	LTR	DESCRIPTION	DATE	DWN	APVD
-	-	SEE SHEET 1	-	-	-

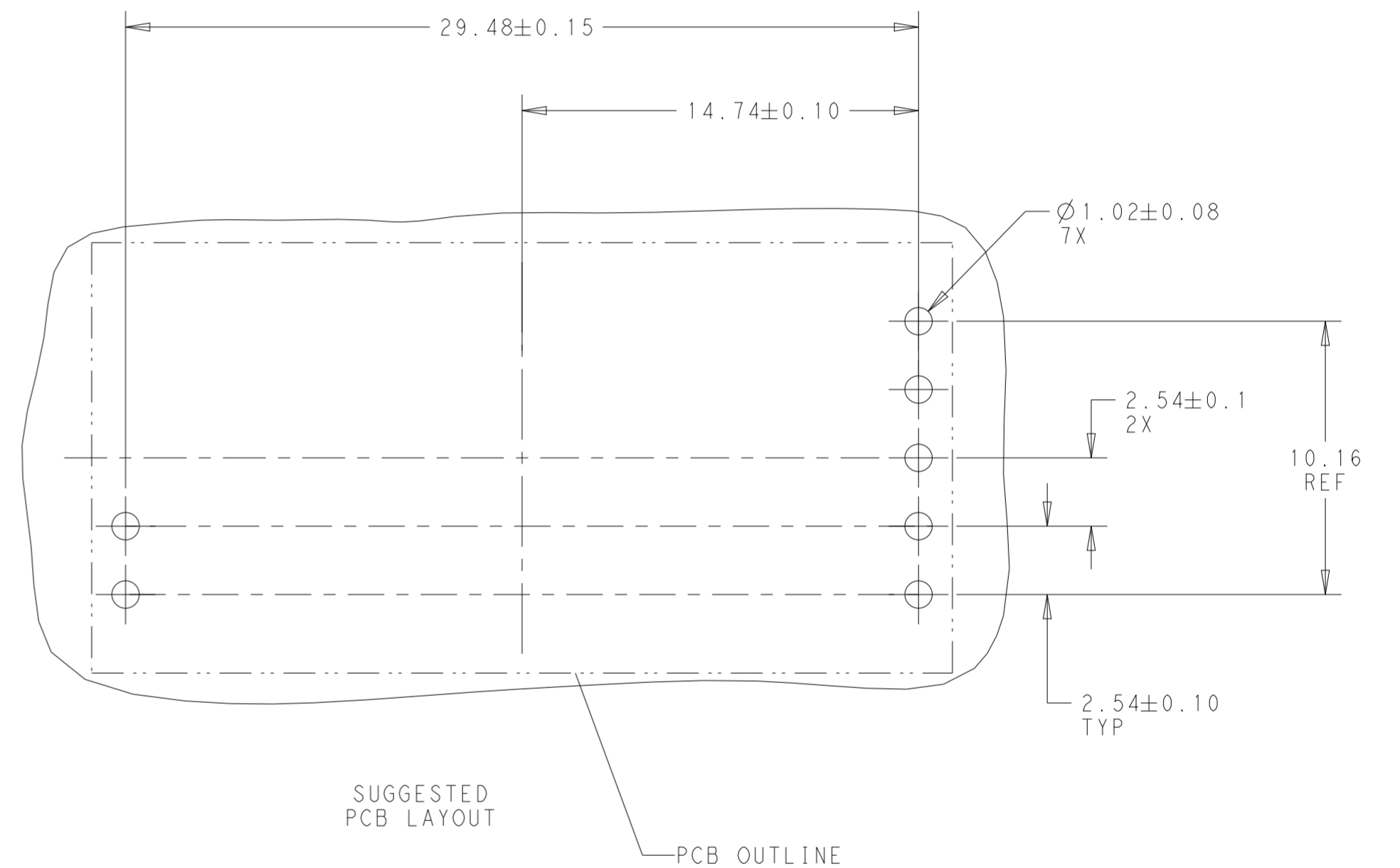
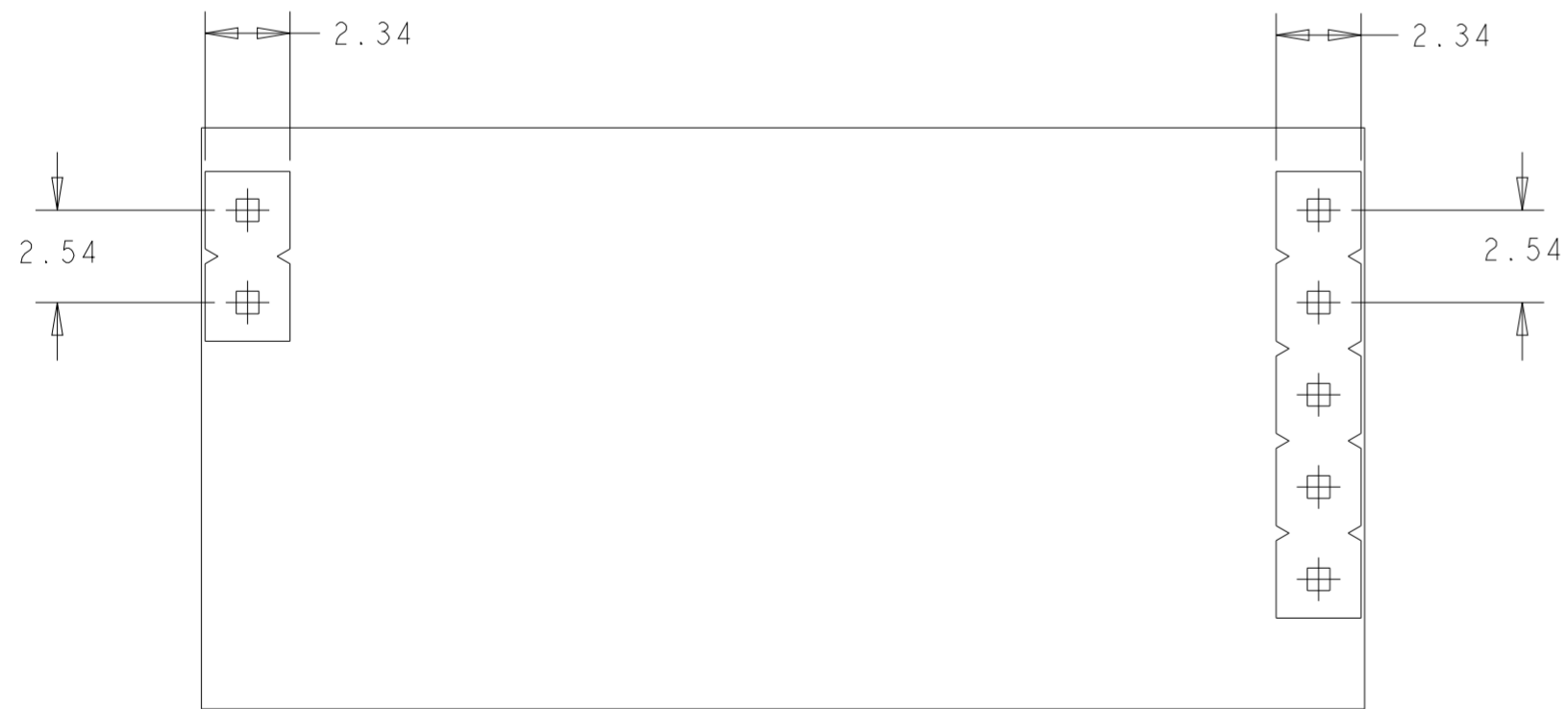
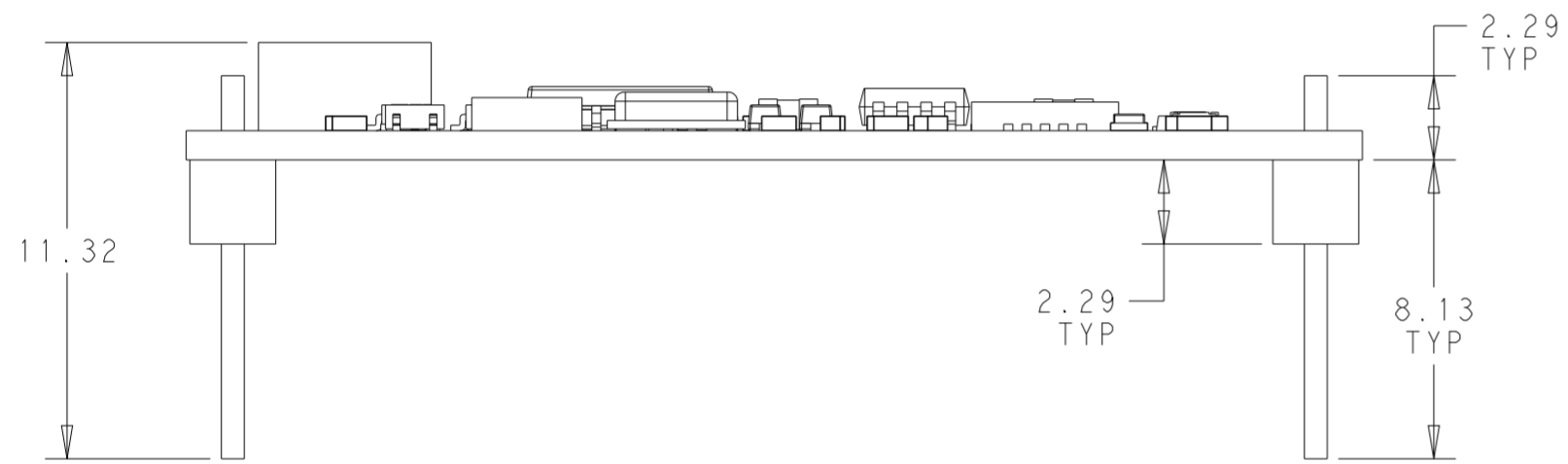
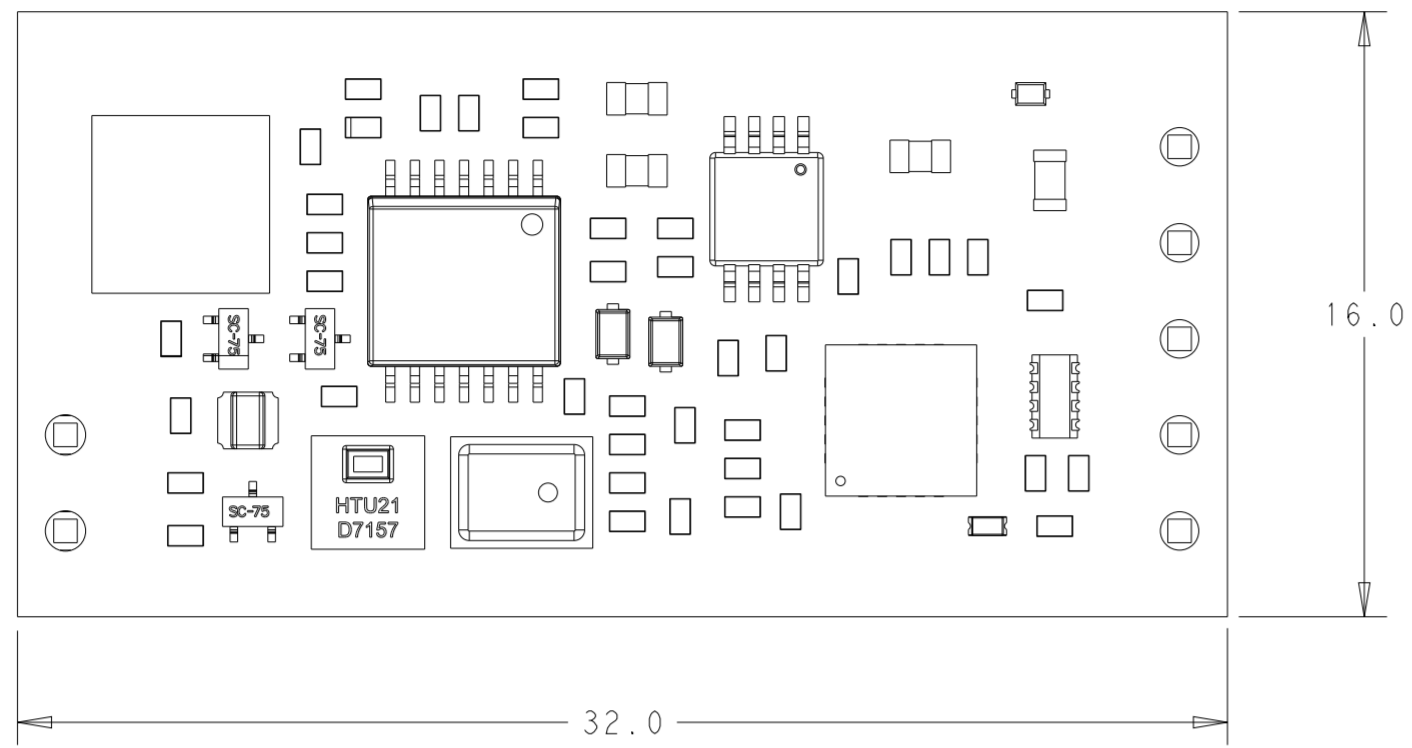

THIS DRAWING IS A CONTROLLED DOCUMENT.		DWN J. SHAFFER 10MAR2017	TE Connectivity	
		CHK C. GINGRICH 10MAR2017		
DIMENSIONS: mm		APVD -	NAME AMBIMATE, MSM4 SENSOR MODULE, THRU HOLE - PIN HEADER	
TOLERANCES UNLESS OTHERWISE SPECIFIED: 0 PLC ± 1 PLC ±0.4 2 PLC ±0.25 3 PLC ± 4 PLC ± ANGLES ± FINISH ±		PRODUCT SPEC 108-133092	DRAWING NO C-2314277	
MATERIAL -		APPLICATION SPEC 114-133092	SIZE A2	RESTRICTED TO -
		WEIGHT -	CAGE CODE -	SCALE 3:1
		CUSTOMER DRAWING	SHEET 2 OF 2	REV B1

Mouser Electronics

Authorized Distributor

Click to View Pricing, Inventory, Delivery & Lifecycle Information:

[TE Connectivity:](#)

[1-2314277-1](#)