

DATA CODE

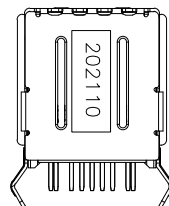

规格说明: Specifications:

电气特性: Electrical:

1. 额定电流: Current Rating: 2.0A/contact terminal
2. 额定电压: Voltage Rating: 30V DC
3. 接触阻抗: Contact Resistance: 30 milliohms MAX
4. 耐压: Dielectric Withstanding Voltage: 300V AC AT Sea Level
5. 绝缘阻抗: Insulation Resistance: 1000MEGA ohms MIN.

物理性能: Mechanical:

1. 插拔力: Connector Mate and Unmate F
Mate force: 3.0kgf(MAX)
Unmate force: 0.7kgf(MIN)
2. 端子保持力: Terminal Retention: 1.2kgf(MIN)

原材料: Material:

1. 塑胶: Housing: Hing Temperature Thermoplastics UI LCP PBT White/Black
2. 端子: Contact: Copper Alloy C5191/C2680
3. 外壳: Shell: Copper Alloy SPCC/C2680

电镀: Finish:

1. 端子: Contact: Plated Gold in Mating Area, Tin On Solder Tails
2. 外壳: Shell: Nickel plating

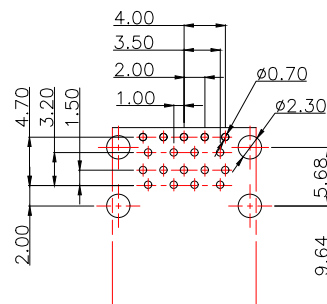
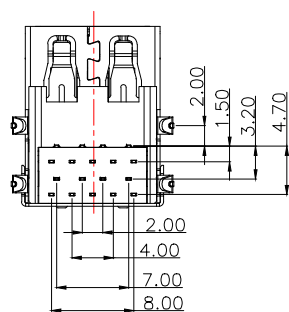
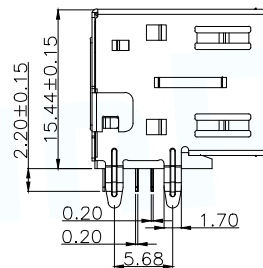
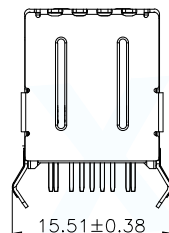
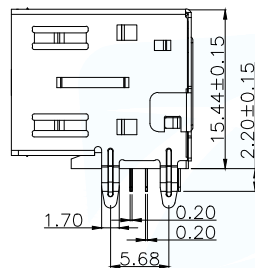
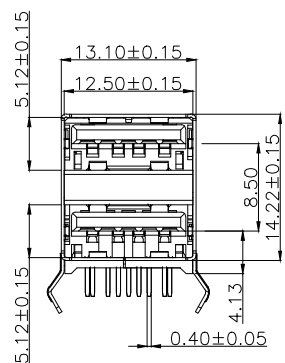

RECOMMENDED P.C.B HOLE LAYOUT TOP VIEW (TOLERANCE: ±0.05)

TERMINAL ASSIGNMENT

CONTACT NUMBER	SIGNAL NAME
1	VBUS
2	D-
3	D+
4	GND

TERMINAL ASSIGNMENT

CONTACT NUMBER	SIGNAL NAME
5	SSTXM-
6	SSTXP+
7	GND
8	SSTXM-
9	SSTXP+

NO.	Part Name	MATERIAL	THICK	FINISH	Q'TY
5	SHELL-B	SUS	T=0.25	Ni:PLATED	1
4	SHELL-A	BRASS	T=0.30	Ni:30u"Min	1
3	TERMINAL-B	BRASS	T=0.2	Sn 60U"+ Au 1U"	4
2	TERMINAL-A	BRASS	T=0.2	Sn 60U"+ Au 1U"	4
1	HOUSING	PBT		BLACK	1

MANUFACTURE DWG		东莞市讯普电子科技有限公司 DongGuan XunPu Electronics Co., Ltd	
UNLESS OTHERWISE SPECIFIED TOLERANCES			TITLE: USB 2.0/3.0 双层90度有益弯脚卷边 18P PAR: USB-303WSD-BRW DWN: Lucas CHKD: Ethan APVD: Jacob SCALE: 1:1 UNIT: MM
DECIMALS:	ANGLES:		SIZE: A4
X.: ±0.50	X': ±1°		SHEET: 1F1
X.X: ±0.25	X.X': ±1'		REV: A
X.XX: ±0.12	X.XX': ±0.5'		