

SOD-123

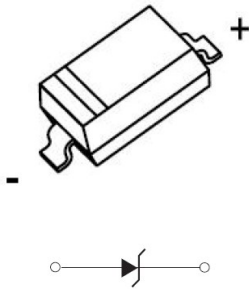

特征 Features

- 齐纳击穿阻抗低; Low Zener Impedance
- 最大功率耗散 500mW; Power Dissipation of 500mW
- 高稳定性和可靠性。High Stability and High Reliability

机械数据 Mechanical Data

- 封装: SOD-123 封装 SOD-123 Small Outline Plastic Package
- 极性: 色环端为负极 Polarity: Color band denotes cathode end
- 环氧树脂 UL 易燃等级 Epoxy UL: 94V-0
- 安装位置: 任意 Mounting Position: Any

极限值和温度特性(TA = 25°C 除非另有规定)

Maximum Ratings & Thermal Characteristics (Ratings at 25°C ambient temperature unless otherwise specified.)

Parameters	符号 Symbol	数值 Value	单位 Unit
Power Dissipation	Pd	500 ¹⁾	mW
Forward Voltage @IF=10mA	Vf	0.9 ²⁾	V
Storage temperature range	Ts	-65-+150	°C
Thermal resistance junction to ambient air	RthA	400	°C/W ¹⁾

- 1) Device mounted on ceramic PCB: 7.6mm x 9.4mm x 0.87mm with pad areas 25mm²
- 2) Short duration test pulse used to minimize self-heating effect
- 3) f=1KHz

电特性 (TA = 25°C 除非另有规定)

Electrical Characteristics (Ratings at 25°C ambient temperature unless otherwise specified.)

Device	Marking	Zener Voltage Range				Maximum Zener Impedance ³⁾			Maximum Reverse Current		Typical Temperature coefficient @ IZTC=mV/°C		Test Current IZTC
		Vz@Izt			Izt	Zzt @Izt	Zzk @Izk	Izk	IR	VR	Min	Max	
		Nom(V)	Min(V)	Max(V)	mA	Ω	Ω	mA	uA	V			
BZT52C15	WJ	15	13.8	15.6	5	30	200	1.0	0.1	10.5	9.2	13.0	5

Breakdown characteristics at Tj=constant (pulsed)

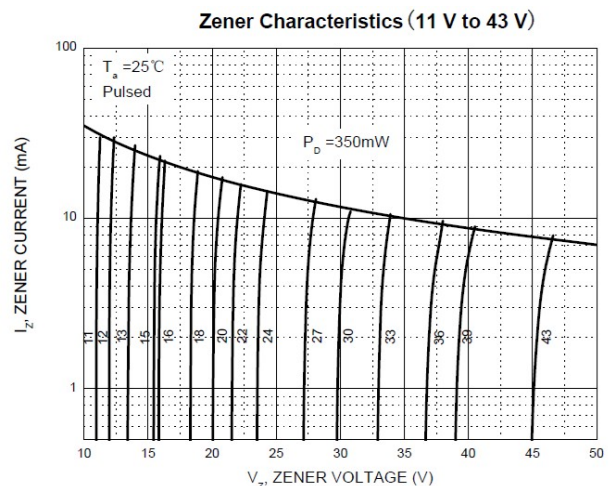
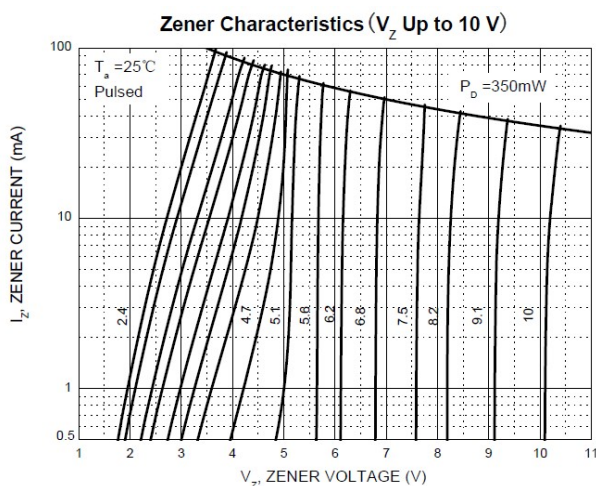

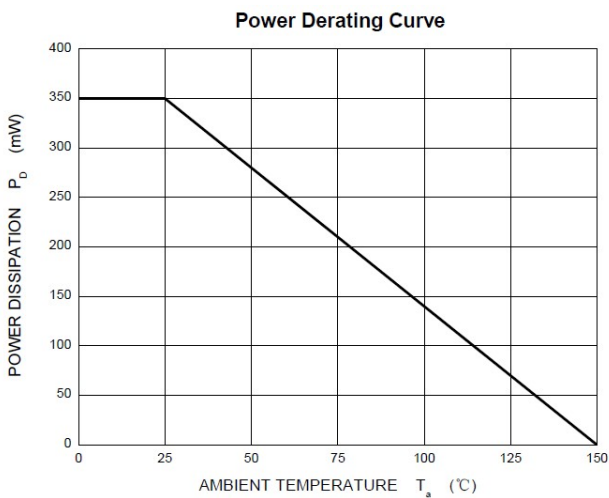
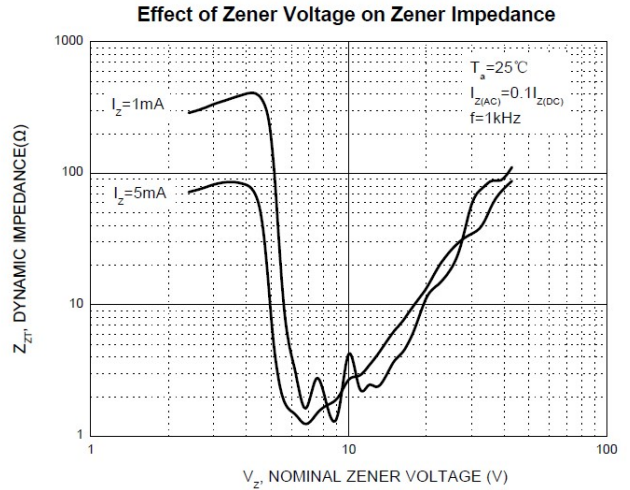
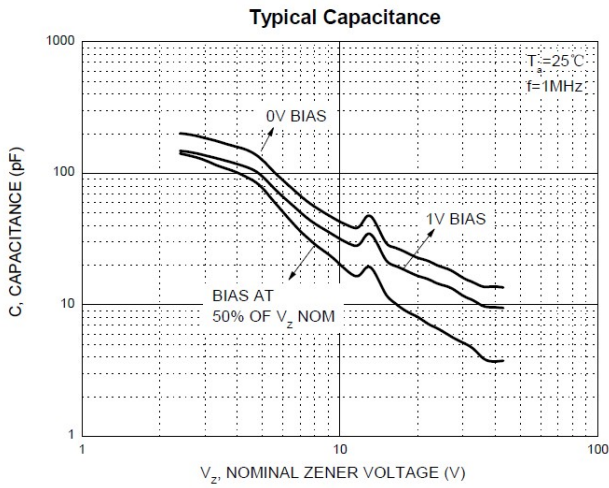
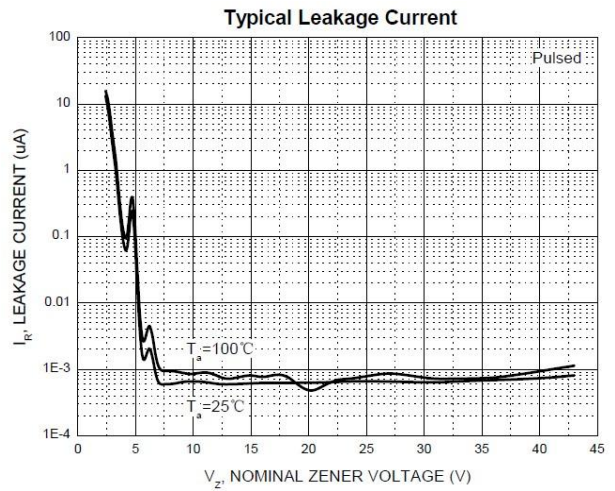
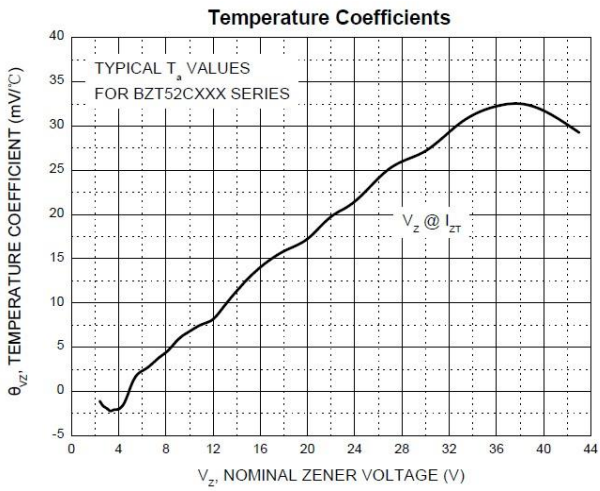

回流焊推荐条件 Reflow Soldering Instructions (SMT)

Number of reflow process shall be less than 2 times and cooling process to normal temperature is required between first and Second soldering process. (标准: JEITA ED-4701)

产品最多只可回焊两次,且在首次回焊后须冷却至室温之后方可进行第二次回焊.

时间: 最多 2 次

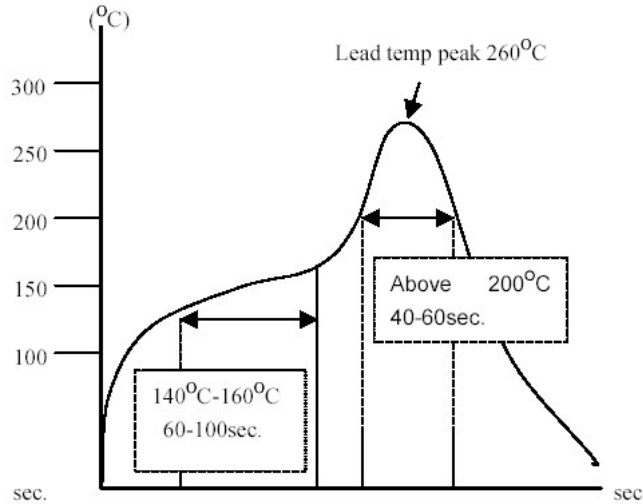
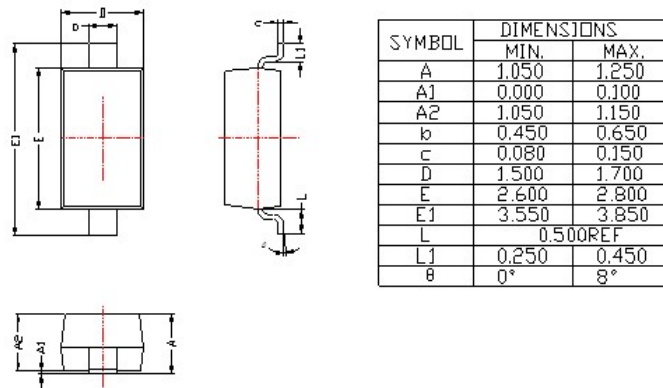

SOD-123 PACKAGE OUTLINE Plastic surface mounted package

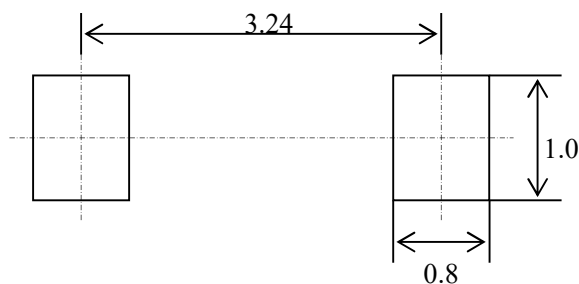
焊盘设计参考 Precautions: PCB Design

Recommended land dimensions for SOD-123 diode. Electrode patterns for PCBs

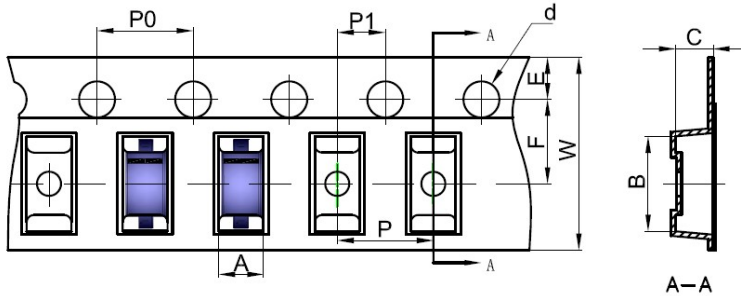

技术要求:
 中心距: 3.24
 脚宽: 0.55
 焊盘宽: 1.00
 脚长: 0.50
 焊盘长: 0.80

技术要求:
 1, 塑封体尺寸: 2.70 X 1.60
 2: 未注公差为: ±0.05
 3, 所有单位: mm

Tape and Reel
SOD-123 Embossed Carrier Tape

Packaging Description:
 SOD-123 parts are shipped in tape. The carrier tape is made from a dissipative (carbon filled) polycarbonate resin. The cover tape is a multilayer film (Heat Activated Adhesive in nature) primarily composed of polyester film, adhesive layer, sealant, and anti-static sprayed agent. These reeled parts in standard option are shipped with 3,000 units per 7" or 17.8cm diameter reel. The reels are clear in color and is made of polystyrene plastic (anti-static coated).

Dimensions are in millimeter										
Pkg type	A	B	C	d	E	F	P0	P	P1	W
SOD-123	1.85	3.95	1.57	Ø1.55	1.75	3.50	4.00	4.00	2.00	8.00

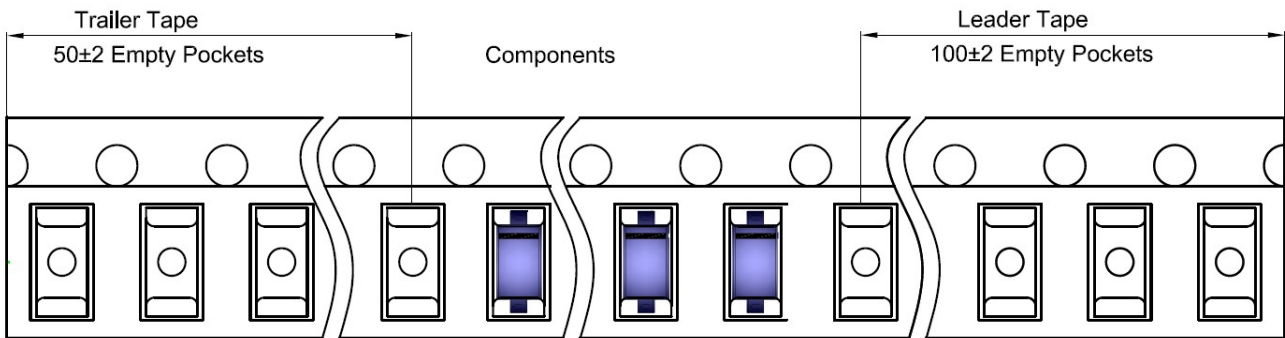
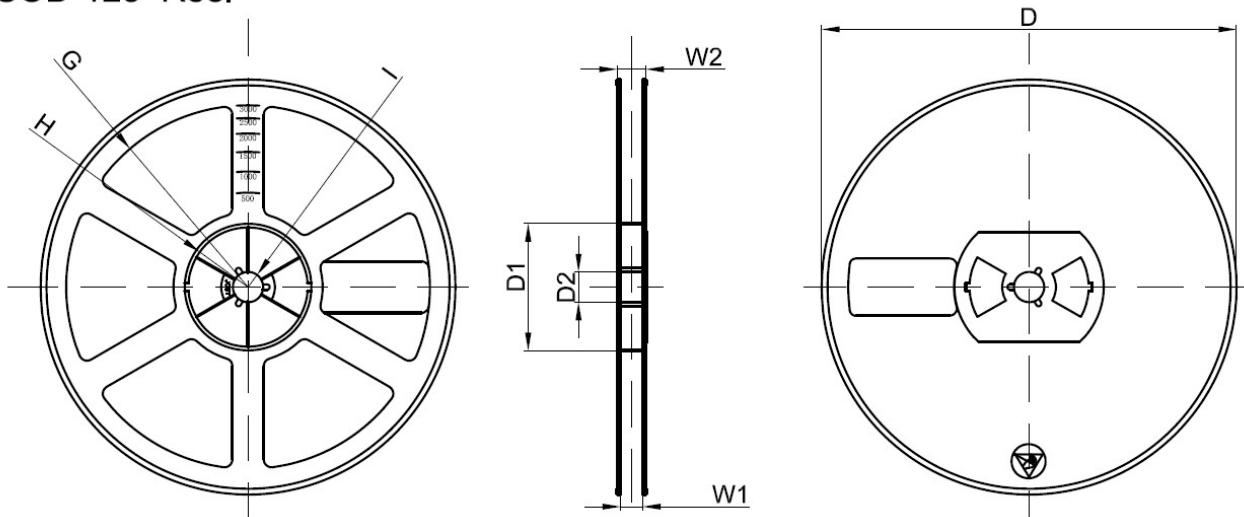
SOD-123 Tape Leader and Trailer

SOD-123 Reel

Dimensions are in millimeter								
Reel Option	D	D1	D2	G	H	I	W1	W2
7"Dia	Ø178.00	54.40	13.00	R78.00	R25.60	R6.50	9.50	12.30

REEL	Reel Size	Box	Box Size(mm)	Carton	Carton Size(mm)	G.W.(kg)
3000 pcs	7 inch	45,000 pcs	203×203×195	180,000 pcs	438×438×220	

NOTICE

The information presented in this document is for reference only. Involving product optimization and productivity improvement, ChipNobo reserves the right to adjust product indicators and upgrade some technical parameters. ChipNobo is entitled to be exempted from liability for any delay or non-delivery of the information disclosure process that occurs.

本文件中提供的信息仅供参考。涉及产品优化和生产效率改善，ChipNobo 有权调整产品指标和部分技术参数的升级，所出现信息披露过程存在延后或者不能送达的情形，ChipNobo 有获免责权。

The product listed herein is designed to be used with residential and commercial equipment, and do not support sensitive items and specialized equipment in areas where sanctions do exist. ChipNobo Co., Ltd or anyone on its behalf, assumes no responsibility or liability for any damages resulting from improper use.

此处列出的产品旨在民用和商业设备上使用，不支持确有制裁地区的敏感项目和特殊设备，ChipNobo 有限公司或其代表，对因不当使用而造成的任何损害不承担任何责任。

For additional information, please visit our website <http://www.chipnobo.com>, or consult your nearest Chipnobo sales office for further assistance.

欲了解更多信息，请访问我们的网站 <http://www.chipnobo.com>，或咨询离您最近的 Chipnobo 销售办事处以获得进一步帮助。