

标记 MARK	ECN编号/变更内容 ECN NO/DEFINITION	修改 REVISE	日期 DATE	核准 APPROVE

CKI	DIM A	DIM B	DIM C	CKI	DIM A	DIM B	DIM C
4	1.50	2.52	5.54	33	16.00	17.02	20.04
5	2.00	3.02	6.04	34	16.50	17.52	20.54
6	2.50	3.52	6.54	35	17.00	18.02	21.04
7	3.00	4.02	7.04	36	17.50	18.52	21.54
8	3.50	4.52	7.54	37	18.00	19.02	22.04
9	4.00	5.02	8.04	38	18.50	19.52	22.54
10	4.50	5.52	8.54	39	19.00	20.02	23.04
11	5.00	6.02	9.04	40	19.50	20.52	23.54
12	5.50	6.52	9.54	41	20.00	21.02	24.04
13	6.00	7.02	10.04	42	20.50	21.52	24.54
14	6.50	7.52	10.54	43	21.00	22.02	25.04
15	7.00	8.02	11.04	44	21.50	22.52	25.54
16	7.50	8.52	11.54	45	22.00	23.02	26.04
17	8.00	9.02	12.04	46	22.50	23.52	26.54
18	8.50	9.52	12.54	47	23.00	24.02	27.04
19	9.00	10.02	13.04	48	23.50	24.52	27.54
20	9.50	10.52	13.54	49	24.00	25.02	28.04
21	10.00	11.02	14.04	50	24.50	25.52	28.54
22	10.50	11.52	14.54	51	25.00	26.02	29.04
23	11.00	12.02	15.04	52	25.50	26.52	29.54
24	11.50	12.52	15.54	53	26.00	27.02	30.04
25	12.00	13.02	16.04	54	26.50	27.52	30.54
26	12.50	13.52	16.54	55	27.00	28.02	31.04
27	13.00	14.02	17.04	56	27.50	28.52	31.54
28	13.50	14.52	17.54	57	28.00	29.02	32.04
29	14.00	15.02	18.04	58	28.50	29.52	32.54
30	14.50	15.52	18.54	59	29.00	30.02	33.04
31	15.00	16.02	19.04	60	29.50	30.52	33.54
32	15.50	16.52	19.54	80	39.50	40.52	43.54

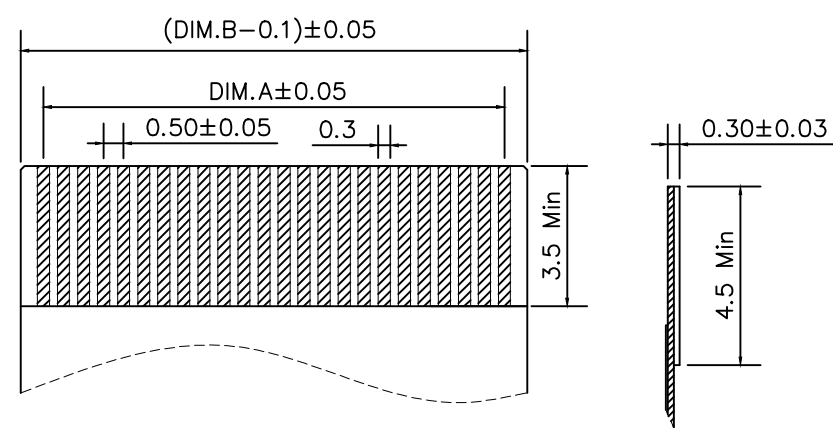

适用扁平线(Applicable Flat Cable)

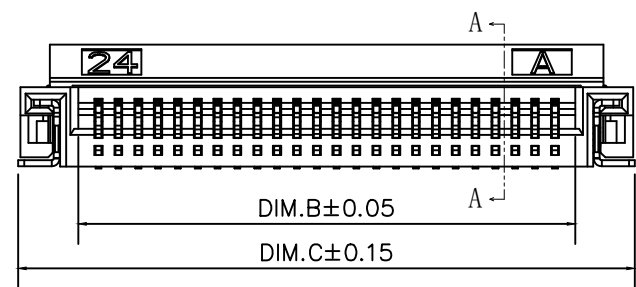
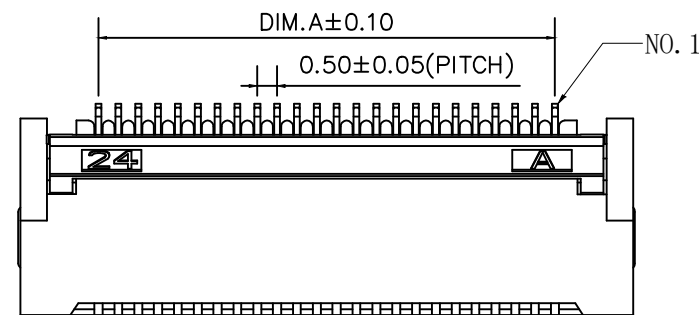
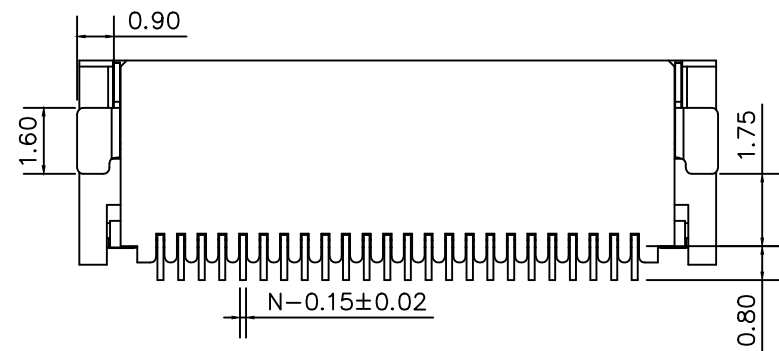
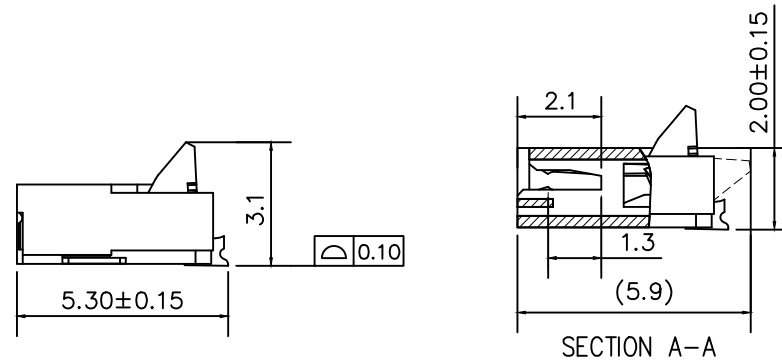
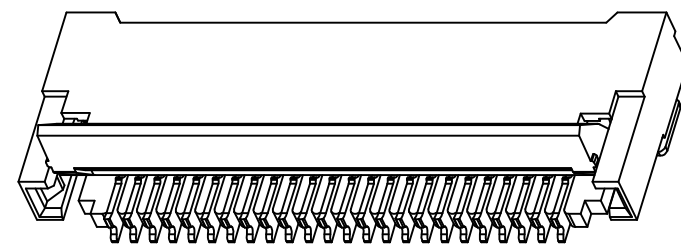
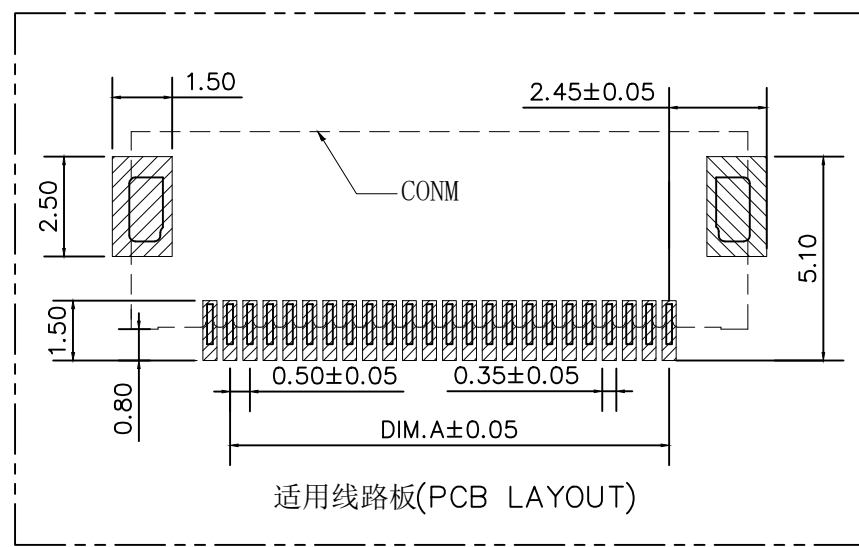

适用线路板(PCB LAYOUT)

技术指标:

- 1. 温度范围: -25°C~85°C
- 2. 额定电压: 50V, AC/DC (等效)
- 3. 接触电阻: ≤0.03Ω
- 4. 绝缘电阻: ≥500MΩ

2	端子	铜	点镀金	
1	胶芯	LCP	本色	
序号	品名	材质	电镀/颜色	备注

深圳市虹成电子有限公司

品名: FPC座
 TITLE: FPC座
 料号: HC-FPC-0.5-10P-FHH20
 PART NO: HC-FPC-0.5-10P-FHH20

GENERAL TOLERANCES (UNLESS SPECIFIED):
 X. ±0.50 .XX ±0.10
 .X ±0.20 .XXX ±0.05
 ANGLES ±1°

比列 SCALE: 1:1
 单位 UNIT: MM
 张数 PART NO: 1 OF 1
 版本 REV: A

制图 DRAW: AhYe
 审核 CHECKED: 夏操云
 批准 APPROVE: 赵亮亮